

Lecture 24: Multivariable Integration (15.1)

Reminder: Exam Week. <http://dunfield.info/241>.

Curves: 

$$\int_C f ds \quad \int_C \vec{F} \cdot d\vec{r}$$

Goal: Surfaces

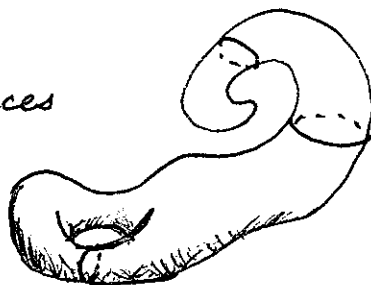

$$\int_S f dA$$

[Things like parametrization, integration will repeat for surfaces...]

One Var:

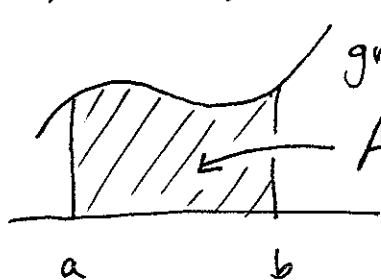

graph of f

$$\text{Area} = \int_a^b f(x) dx$$

[Computed using the Fund. Thm. of Calc.]

Two Var:

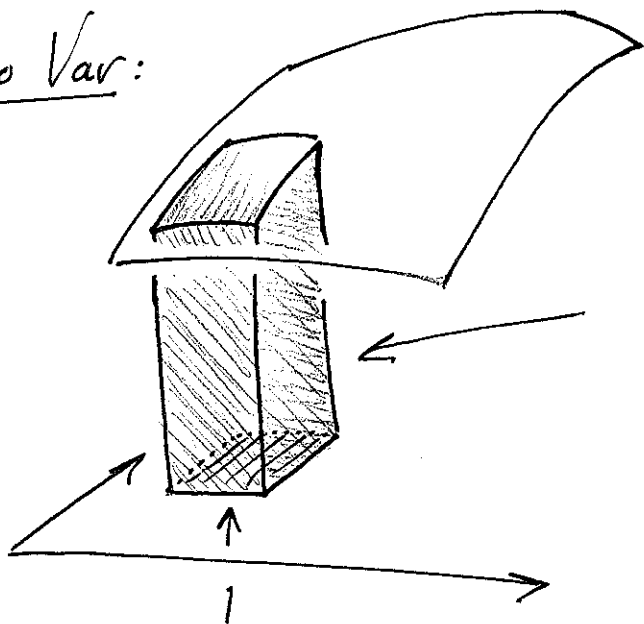

graph of $f: \mathbb{R}^2 \rightarrow \mathbb{R}$

$$\text{Volume is } \iint_R f(x,y) dA$$

Base R , a square

Q1: How do we formulate volume mathematically?

Q2: How do we compute it?

Recall:

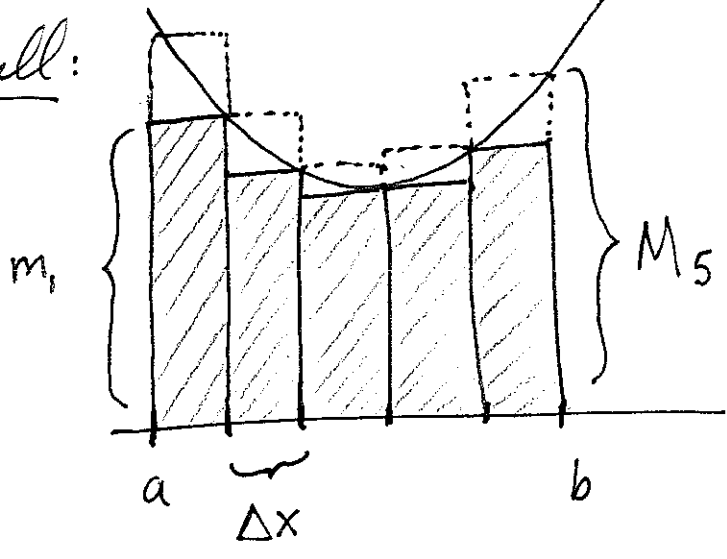

$m_i = \text{min of } f \text{ on } i^{\text{th}} \text{ subinterval}$

$M_i = \text{max of } f \text{ on } i^{\text{th}} \text{ subinterval.}$

Then

$$\sum_{i=1}^n m_i \Delta x \leq \int_a^b f(x) dx \leq \sum_{i=1}^n M_i \Delta x$$

If f is continuous, then as $\Delta x \rightarrow 0$ the two bounds converge to the thing in the middle.

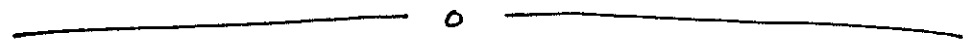

Two Var

R:

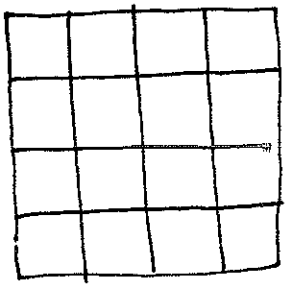

Each square  Δy
 Δx

has area $\Delta x \Delta y$.

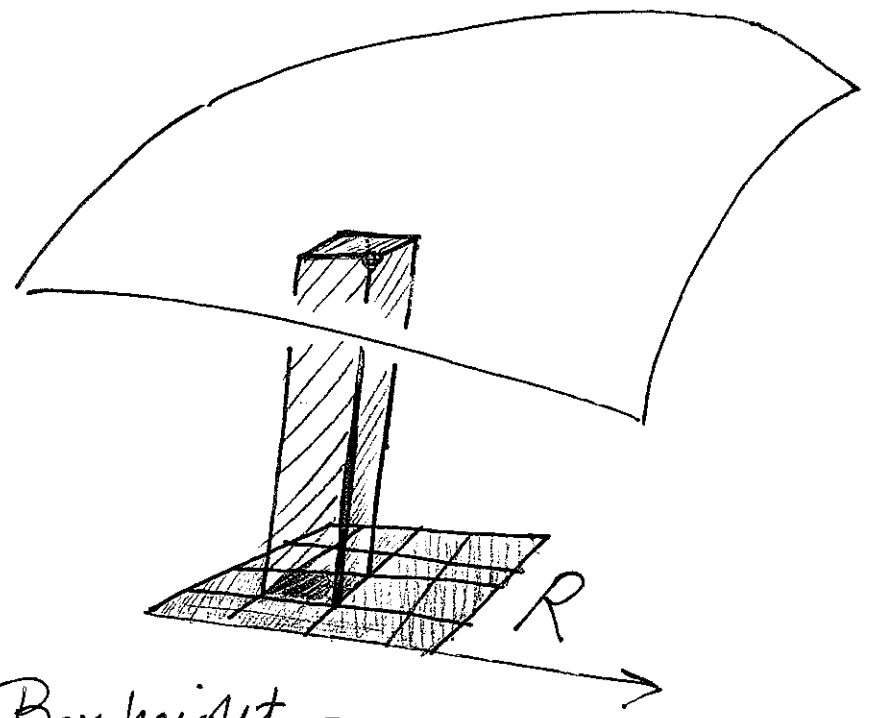

Box height =
 min of f on the
 subsquare.

Thus

$$\sum_{\text{small squares}} \left(\begin{array}{l} \text{min of } f \\ \text{on subsquare} \end{array} \right) \Delta x \Delta y \leq \iint_R f(x,y) dA$$

$$\leq \sum_{\text{small squares}} \left(\begin{array}{l} \text{max of } f \\ \text{on subsquare} \end{array} \right) \Delta x \Delta y$$

As $\Delta x, \Delta y \rightarrow 0$ these bounds converge to define the integral. [Provided f is continuous.]

Q2: How do we compute it?

Archimedes (225 B.C.E.)

3 : 2

volume and surface area!

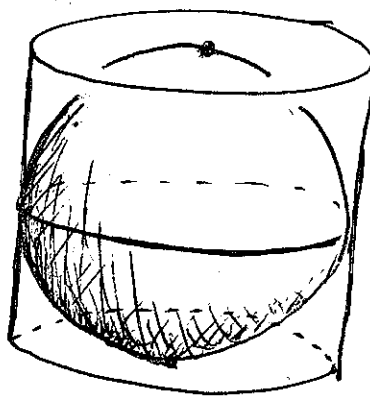

Key: Reduce to one var integrals by slicing.

Let $A(y)$ be the area of the cross section with the given y coord.

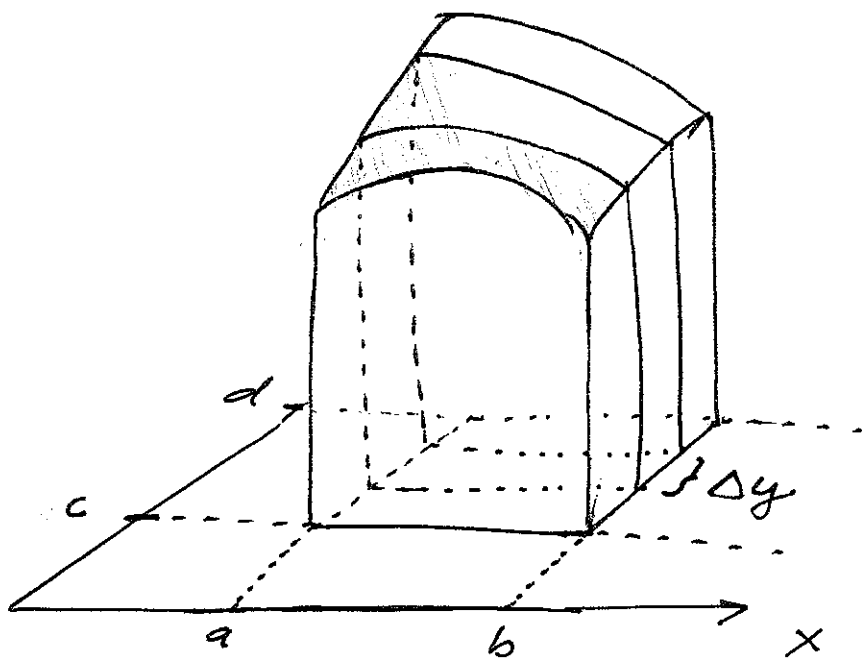

Volume of a slice
is $\approx A(y)\Delta y$

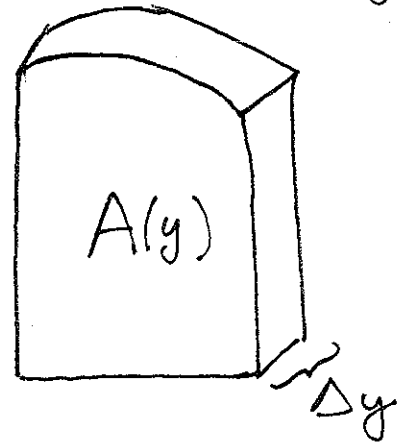

Add to get
total volume

So

$$\iint_R f(x,y) dA = \int_c^d A(y) dy$$

$$= \int_c^d \left(\int_a^b f(x,y) dx \right) dy$$

y is fixed

$$= \int_a^b \left(\int_c^d f(x,y) dy \right) dx.$$

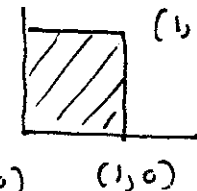
Ex: $f(x,y) = x^2 + y^2 + 5$ $R =$ 

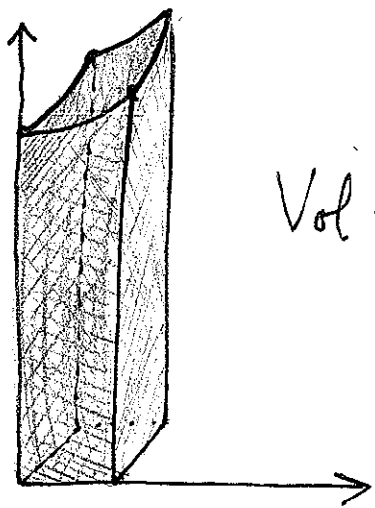

$$\text{Vol} = \iint f(x,y) dA = \int_0^1 \left(\int_0^1 (x^2 + y^2 + 5) dx \right) dy$$

$$= \int_0^1 \left(\frac{x^3}{3} + (y^2 + 5)x \Big|_{x=0}^{x=1} \right) dy$$

$$= \int_0^1 \left(\frac{1}{3} + (y^2 + 5) \right) dy = \frac{16}{3}y + \frac{y^3}{3} \Big|_{y=0}^{y=1} = \frac{17}{3} = 5 \frac{2}{3}$$

Next time: Dealing with regions R which are not rectangles

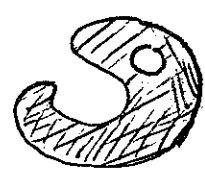

Idea: Break into small boxes.

Other meanings of the integral:

① $\iint_R 1 dA = \text{Area of } R$

$dA = d(\text{Area})$

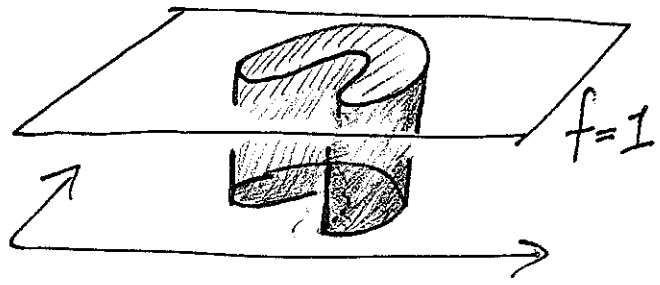

$\text{Vol} = (\text{height}) \cdot (\text{Area})$

② Average of $f: \mathbb{R}^2 \rightarrow \mathbb{R}$ on R is

$$\text{Average} = \frac{1}{\text{Area}(R)} \iint_R f \, dA$$

③ R made of material with density given by $\rho: \mathbb{R}^2 \rightarrow \mathbb{R}$. Then

$$\text{Total Mass} = \iint_R \rho \, dA.$$